

# Roda S/120

Coming soon!

Diseño / Design:  
Joana Bover / 2022

Tipología: Suspensión  
Typology: Pendant lamp

Ambiente: Interior  
Environment: Indoor

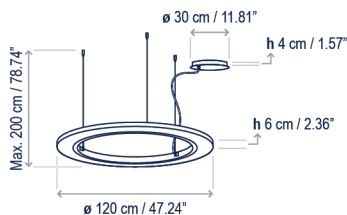
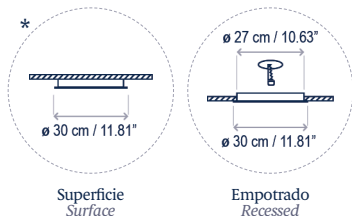

## Descripción técnica / Technical description:

Peso Neto: 0,00 kg  
Net Weight: 0,00 kg

1 Caja/Box | 00 x 00 x 00 cm | 0,0000 m<sup>3</sup>  
Peso bruto / Gross Weight: 0,00 kg

Materiales: Aluminio, Acero, Cinta  
Materials: Aluminum, Steel, Ribbon

\*El florón puede instalarse empotrado o en superficie según la necesidad.  
\*The canopy can be installed recessed/surface depending on the customer needs.

Opción Dali: consultar  
Dali option: consult

Para regulaciones Casambi, consultar  
For Casambi dimmers, consult

Personalizable: consultar  
Customizable: consult

Certificaciones  
Certifications

## Descripción lámpara / Lamps description:

120-277V 50/60Hz | IP-20 | 1-10V | 49 W LED / CRI: 90 / 2700K  
2160 lm fuente de luz / light source

Ref	Acabados / Finishing	Ean13
36601210189	Regulable 1-10V - Marrón Pantalla Cinta Translúcida Blanca Dimmable 1-10V - Brown White Translucent Ribbon Shade	8435493714172
36601210190	Regulable 1-10V - Marrón Pantalla Cinta Translúcida Crema Dimmable 1-10V - Brown Cream Translucent Ribbon Shade	8435493714165

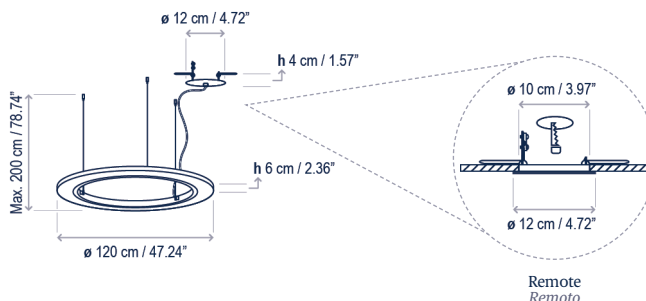

## Descripción lámpara (Driver remoto) / Lamps description (Remote driver):

120-277V 50/60Hz | IP-20 | 1-10V | 49 W LED / CRI: 90 / 2700K  
2160 lm fuente de luz / light source

Ref	Acabados / Finishing	Ean13
36601222189	Regulable 1-10V - Marrón Pantalla Cinta Translúcida Blanca Dimmable 1-10V - Brown White Translucent Ribbon Shade	8435493739946
36601222190	Regulable 1-10V - Marrón Pantalla Cinta Translúcida Crema Dimmable 1-10V - Brown Cream Translucent Ribbon Shade	8435493739953

**bover**  
barcelona lights

Avda. Catalunya 173  
Poligon Ind. Sud  
08440 Cardedeu  
Barcelona, Spain

T. +34 938 713 152  
F. +34 938 462 089  
info@bover.es  
www.bover.es

## Familia / Family: Roda

